

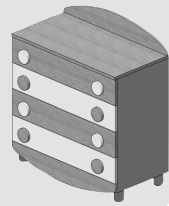

FOPPAPEDRETTI®
l'albero delle idee

FOPPAPEDRETTI®

Made in Italy



Favola *NEW*

cassettiera
chest of drawers
commode

kommode
cajonera
ladenkast

Istruzione montaggio e uso
Instructions for assembly and use
Instructions de montage et mode d'emploi
Montage- und Gebrauchsanweisung
Instrucciones de montaje y uso
Aanwijzingen voor de montage en het gebruik

Avvertenze

Warning

Avvertissement

Warnung

Advertencias

Waarschuwingen

Leggere attentamente e conservare per future referenze

- Accertarsi del corretto montaggio prima del suo impiego.
- Controllate periodicamente il perfetto bloccaggio delle viti.
- Pulire con un panno umido o con detergente neutro (*no solventi*) e asciugare accuratamente.

Read the instructions carefully and keep for future reference

- Make sure the item has been assembled correctly before use.
- Every so often check that the assembly screws are tightened securely.
- Clean with a damp cloth or with neutral detergent (*no solvents*) and dry carefully.

Lire attentivement et conserver en cas de besoin

- S'assurer que le montage est correct avant son emploi.
- Contrôlez régulièrement que les vis de fixation soient bien bloquées.
- Nettoyez à l'aide d'un chiffon humide ou de détergent neutre (*non-solvants*) puis essuyez-le soigneusement.

Aufmerksam lesen und für zukünftige Referenzen aufbewahren

- Mit einem feuchten Tuch oder einem neutralen.
- Kontrollieren Sie regelmäßig, daß die Montageschrauben immer gut festgezogen sind.
- Mit einem feuchtem Tuch oder neutralem Reinigungsmittel (*keine Lösungsmittel*) reinigen und gut abtrocknen.

Leer atentamente y conservar para futuras referencias

- Asegurarse que el montaje sea correcto antes de su utilización.
- Controlar periódicamente que los tornillos de montaje estén siempre bien bloqueados.
- Limpiar con un paño húmedo o con detergente neutro (*no con solventes*) y secar cuidadosamente.

Lees deze aanwijzingen met aandacht en bewaar ze voor gebruik later

- Voor gebruik controleren dat de montage op de juiste wijze is uitgevoerd.
- Controleer regelmatig dat de montageschroeven altijd goed zijn vastgezet.
- Met een vochtige doek of een neutraal reinigingsmiddel (*geen oplosmiddelen*) schoonmaken en zorgvuldig droogmaken.

Composizione

Composition

Composition

Materialien

Composición

Materialen

- Struttura e cassetti in truciolare nobilitato
- Fianchi cassetti in truciolare ricoperti in pvc.
- Piedini in legno.
- Decoro versione "Vaniglia Cioccolato" in MDF.
- Decoro cassetto "Amici del cuore-Coccodè" dipinto a mano.
- Maniglie in legno di faggio o ABS verniciato.

- Struktur und Schubladen aus Spanplatten mit Melamin.
- Schubladenwände aus Spanplatten mit PVC-Bekleidung.
- Füßchen aus Holz.
- Dekor Version "Vaniglia Cioccolato" in MDF.
- Fachdekoration "Amici del cuore-Coccodè" handgemalt.
- Griffe in Buche oder lackierten ABS.

- Chipboard frame and drawers covered in melamine.
- Chipboard drawer sides covered in pvc.
- Wooden feet.
- Decorations of the "Vaniglia Cioccolato" version are in MDF.
- Hand-painted decoration for "Amici del cuore-Coccodè" drawer.
- Handles in beech or painted ABS.

- Estructura y cajones de aglomerado recubierto con melamina.
- Laterales de los cajones de aglomerado recubierto con PVC.
- Patas de madera.
- Decoración de la versión "Vaniglia Cioccolato" en MDF.
- Decoración cajon "Amici del cuore-Coccodè" pintado a mano.
- Manijas en madera de haya o pintado ABS.

- Structure et tiroirs en particules revêtues mélamine.
- Flancs des tiroirs en particules revêtues pvc.
- Piétements en bois.
- Décorations version "Vaniglia Cioccolato" en MDF.
- Décor de tiroir "Amici del cuore-Coccodè" peint à la main.
- Poignées en hêtre ou peint ABS.

- Kast en laden van spaanplaat met deklaag van melamine.
- Zijpanelen van laden van spaanplaat met pvc-deklaag.
- Poten van hout.
- Decoraties van MDF in de kleuren "Vaniglia Cioccolato".
- Decor lade "Amici del cuore-Coccodè" met de hand geschilderd.
- Handgrepen in beuken of gelakt ABS.

Componenti

Component parts

Composants

Bestandteile

Componentes

Onderdelen

a. x6



cod.0029010200

b. x5



cod.0049754500

c. x5



cod.0049754451

d. x4



cod.0030004560

e. x4



cod.0029415728

f. x4
Coccodè



cod.0029053213

f. x8
altre vers.



cod.00290532...

f. x8
Righe & Pois



cod.00447220...

g. x4
Coccodè



cod.0030632960

g. x8
altre vers.



cod.0030632960

h.



cod.00901785...

Montaggio

Assembly

Assemblage

Montage

Montaje

Montage

1

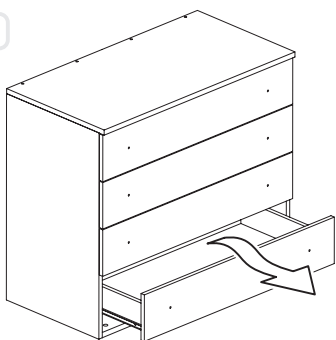

2

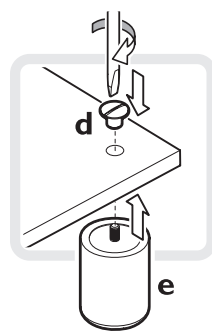
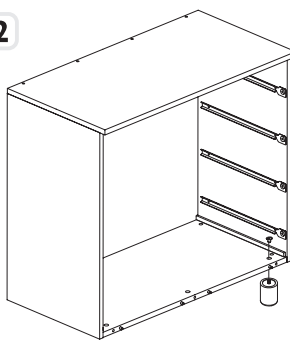

3

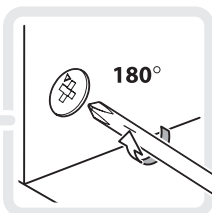
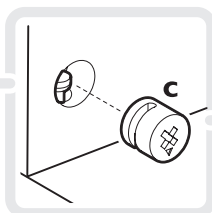
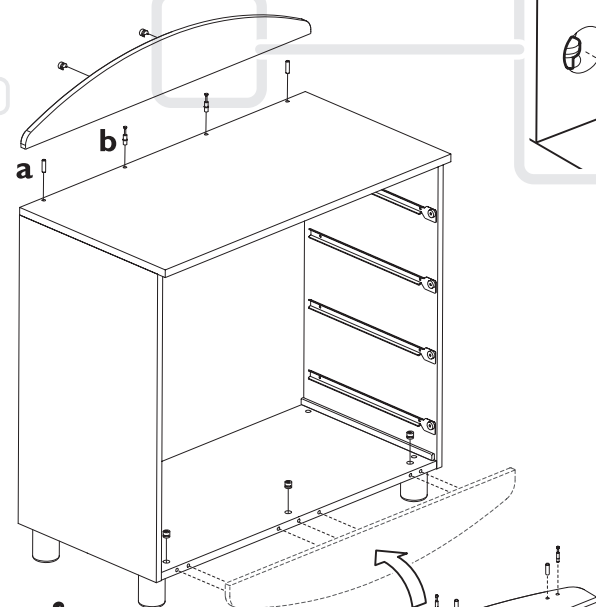

4

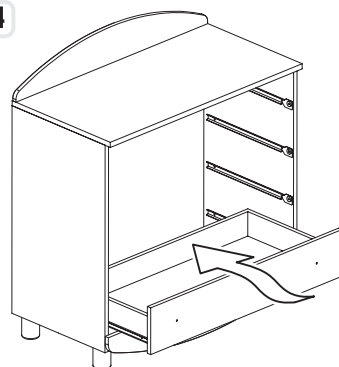

5

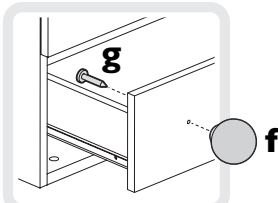

nat - noce - bianco

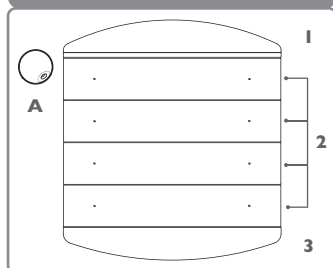

vaniglia & cioccolato

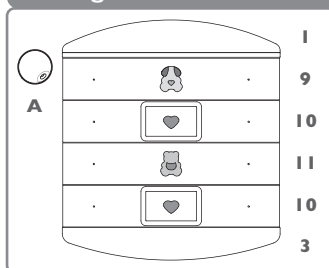

righe & pois

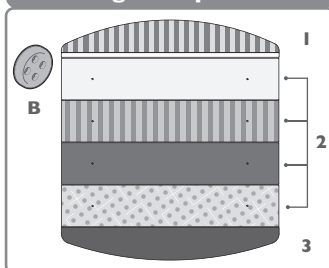

coriandoli

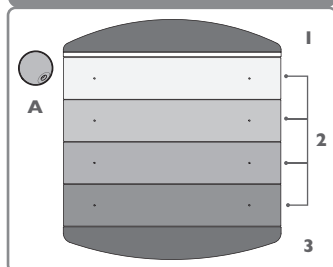

amici del cuore

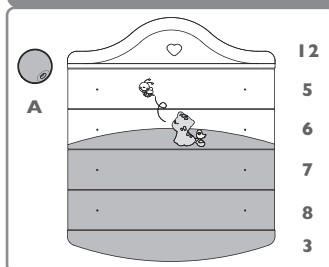

dolce orso

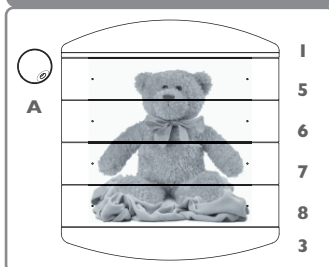

coccodè

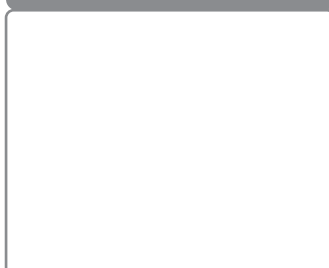
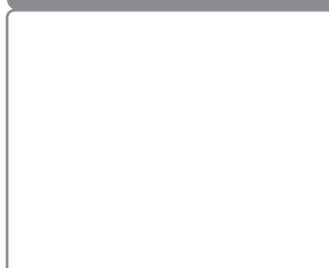
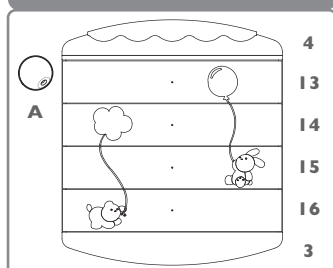

CODICI FRONTALI CASSETTI E MEZZELUNE

1 cod. 00901699 ..

5 cod. 00902780 ..

9 cod. 0090267305

13 cod. 0090379321

2 cod. 00901786 ..

6 cod. 00902781 ..

10 cod. 0090267405

14 cod. 0090379421

3 cod. 00901768 ..

7 cod. 00902782 ..

11 cod. 0090267505

15 cod. 0090379521

4 cod. 0090379721

8 cod. 00902783 ..

12 cod. 0090178934

16 cod. 0090379621

Finali cod. COLORI CASSETTI

03 - naturale

10 - bianco

37 - azzurro coriandoli

65 - righe rosse

93 - giallo righe & pois

05 - avorio

22 - giallo coriandoli

39 - lilla coriandoli

91 rosso righe & pois

94 - pois verdi

06 - noce

354 - amici del cuore

42 - verde coriandoli

92 - blu righe & pois

95 - righe verdi

Maniglie

altre versioni



naturale cod.0029053203

noce cod.0029053206

bianco cod.0029053210

avorio cod.0029053213

versione Righe & Pois



giallo cod.0044722022

blu cod.0044722037

verde cod.0044722041

rosso cod.0044722050

Ogni codice ricambio deve essere sempre composto da dieci cifre: completare gli eventuali codici da otto cifre con le due indicanti il colore. **Attenzione:** le sostituzioni devono essere richieste solamente tramite il rivenditore.

Every code reciprocation always must be composed from ten figures: to complete the eventual codes from eight indicating figures with the two color. **Note:** the replacement parts may only be ordered through the retailer.

Chaque code je rends doit être toujours composé de dix chiffres : compléter les éventuels codes de huit chiffres avec deux heures indiquant la couleur. **Attention:** les substitutions ne peuvent être effectuées que par l'intermédiaire du revendeur.

Jeder Code gebe ich zurück muß mich immer aus zehn Zahlen zusammensetzen: die möglichen Codes von acht Zahlen mit zwei Stunden zu vervollständigen, die die Farbe angeben. **Wichtig:** ersatz darf nur über den Händler angefordert werden.

Cada código vuelvo debo siempre ser compuesto de diez cifras: completar los posibles códigos de ocho cifras con las dos horas que indican el color. **¡Atención!** las sustituciones deben ser solicitadas solamente a través del revendedor.

Elke code geef ik moet altijd uit tien cijfers samengesteld zijn terug: de eventuele codes van acht cijfers met twee uur aanvullen dat de kleur aangeeft. **Opgelet:** vervangingen dienen uitsluitend van de wederverkoper te worden besteld.

Naturale	03	Noce	06	Amici del cuore	34		
Dolce orso	04	Bianco	10	Coriandoli	40		
Lattemiele	05	Coccodè	21	Righe & Pois	64		

FOPPA PEDRETTI

Foppa Pedretti S.p.A. Via A. Volta, 11
24064 - Grumolo del Monte, Bergamo - Italy
tel +39 035.830.497 fax +39 035.831.283

FOPPAPEDRETTI®

ricambi

Favola

Cassettera
Chest of drawers
Commode

Kommode
Cajonera
ladenkast

Ricambi

Spare parts

Pièces de rechange

Austauschteile

Repuestos

Onderdelen

nat - noce - bianco

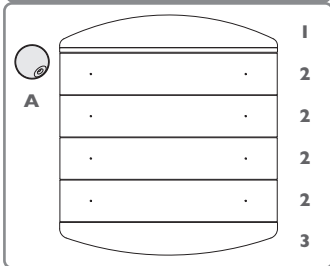

vaniglia & cioccolato

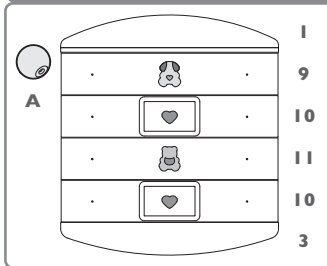

righe & pois

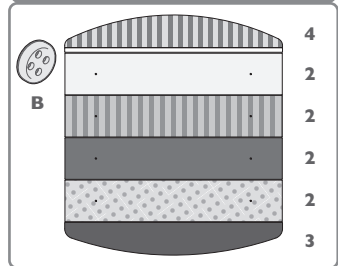

coriandoli

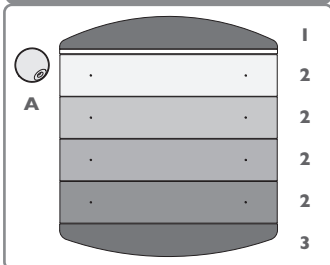

amici del cuore

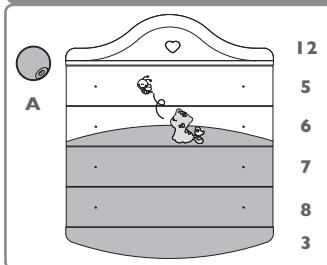

Finali cod. COLORI CASSETTI

03 naturale	10 bianco	37 azzurro coriandoli	65 righe rosse	93 giallo righe & pois
05 avorio	22 giallo coriandoli	39 lilla coriandoli	91 rosso righe & pois	94 pois verdi
06 noce	34 amici del cuore	42 verde coriandoli	92 blu righe & pois	95 righe verdi

CODICI FRONTALI CASSETTI E MEZZELUNE

1 cod. 00901699 ..	4 cod. 00901787 ..	7 cod. 0090278234	10 cod. 00902674 ..
2 cod. 00901786 ..	5 cod. 0090278034	8 cod. 0090278334	11 cod. 00902675 ..
3 cod. 00901768 ..	6 cod. 0090278134	9 cod. 00902673 ..	12 cod. 0090178934